

Engine 4TNV98
Engine power 46,3 kW - 62,9 HP
Operating Weight 9.000 kg

ES 85 ZT

Concrete solutions. Always



TECHNICALS SPECIFICATIONS

Operating weight (with rubber track)	kg	9.000
Operating weight (with steel track)	kg	9.320
Travelling speed (AUTO TWO SPEED)	km/h	1 ^a : 0 ÷ 2,6 / 2 ^a : 0 ÷ 5,2
Slew speed	rpm	10

ENGINE		
Type	YANMAR 4TNV98	
Power (2.200 rpm)	kW - HP	46,3 - 62,9
Displacement	cc	3.319
Number of cylinders	n°	4
Cooling	water	
Consumption	lt/h	8,7
Alternator	V (A)	12 (55)
Battery	V (Ah)	12 (100)

HYDRAULIC SYSTEM		
Circuit Type	Load Sensing closed center system with "Flow Sharing" control valve	
Pump type	1 LS variable pump + 1 gear pump	
Pump displacement	cc	84 + 9
Pump capacity	lt/min	185 + 20
Max. circuit calibration pressure	bar	290 - 200 - 35
Auxiliary Flow (max pressure):	lt/min (bar)	100 / 100 (200) 90 / 80 (290)
AUX 1 main high flow simple or double effect AUX 2 double effect		

PERFORMANCES		
Max digging depth standard arm (optional arm)	mm	4.270 (4.620)
Max dumping height with cab standard arm (optional arm)	mm	4.660 (4.870)
Bucket breaking force (standard arm) ISO 6015	daN	5.850
Arm breaking force (standard arm) ISO 6015	daN	4.350
Traction force	daN	7.960
Ground bearing pressure with rubber tracks	kg/cm ²	0,43
Max slope	60% - 30°	

DIMENSIONS		
Maximum width	mm	2.320
Total height	mm	2.560
Rear rotation radius	mm	1.155
Digging arm length std (optional)	mm	1.760 (2.110)
Tracks width	mm	450
Rollers number (for each side)	n°	5/1 (rubber track) 6/1 (steel track)

FILLINGS		
Fuel tank	lt	105
Hydraulic oil tank	lt	90
Hydraulic circuit capacity	lt	120
Cooling system capacity	lt	25
Engine oil	lt	10

CONTROLS	
Boom, dipper stick, bucket and turret swing	2 pilot joysticks
Tracks movement (included counter rotation)	2 pilot levers
Dozer blade	pilot lever
Auxiliary circuit main high flow with latch AUX 1 (simple or double effect)	electroproportional switch on right joystick
Auxiliary circuit AUX 2 (double effect)	electroproportional switch on right joystick
Boom swing	electroproportional switch on left joystick

ES 85 ZT

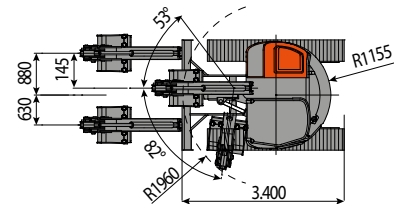
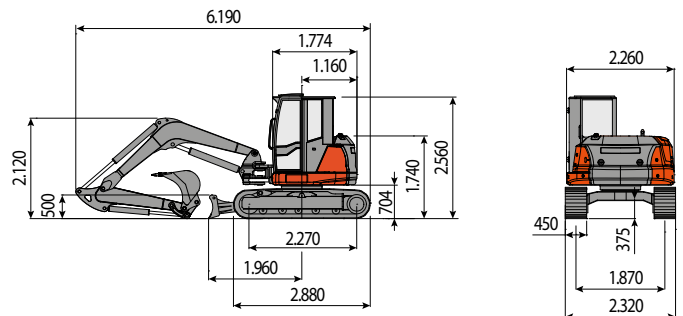
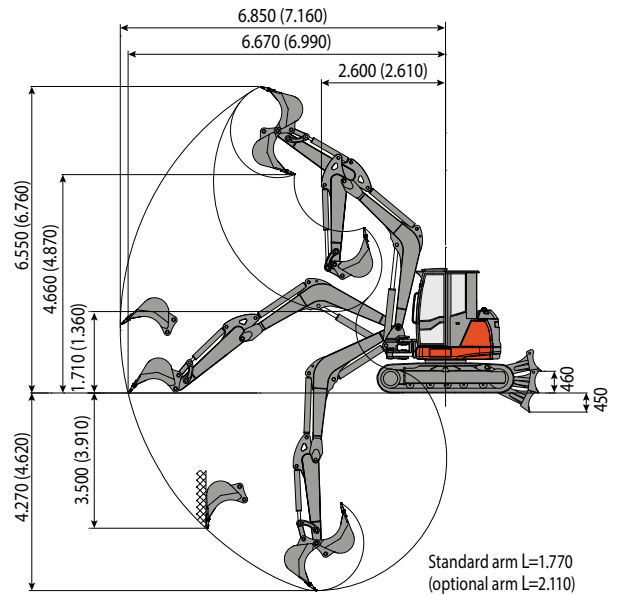

LIFTING CAPACITY				
Opening arm from the rotation's center (m)				
Lifting capacity (kg) at 1.5 m height				
	3	4	5	MAX
Frontal and lowered dozer blade	4495	3045	2350	2085
Frontal and lifted dozer blade	2810	1760	1310	1000
Lateral	2860	1880	1320	1000

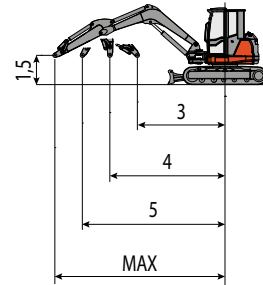

The lifting capacity is based on the ISO 10567 and it does not exceed more than the 75% of static tipping load or more than the 87% of the hydraulic lifting capacity of the machine.



Sampierana S.p.A.

47021 S.Piero in Bagno (FC)

via Leonardo da Vinci, 40

Tel +39 0543.904211

Fax +39 0543.918520

www.eurocomach.com